

**Optimizing Indoor Tracking System for Wireless  
Sensor Networks Using ZigBee**

تحسين نظام تتبع داخلي لشبكات الاستشعار اللاسلكية باستخدام ZigBee

**Prepared By**

**Ahmad H. Mahafzah**

**Supervisor**

**Dr. Hesham Abusaimeh**

**A Thesis Submitted in Partial Fulfillment of the Requirements for  
the Degree of Master in Computer Science**

**Department of Computer Science**

**Faculty of Information Technology**

**Middle East University**

**Jun, 2018**

## Authorization

I, **Ahmad Hani Mohammad Mahafzah**, authorize Middle East University (MEU) to provide copies of my thesis to the concerned libraries, establishments, and institutions upon request.

Name: Ahmad Hani Mahafzah

Date: 11-6-2017

Signature: 

## Examination Committee Decision

This is to certify that the thesis entitled “Optimizing Indoor Tracking System for Wireless Sensor Networks Using ZigBee” was successfully defended and approved on 03-06-2018.

### Examination Committee Members

### Signature

*(Chairman of Examination Committee and Supervisor)*

**Prof. Hesham Abusaimeh**

*Associate Professor, Department of Computer Science*

*Dean Faculty of Graduate Student & Scientific Research*

*Middle East University*

*(Internal Committee Member)*

**Dr. Mudahfar AL-Jarrah**

*Associate Professor, Department of Computer Science*

*Middle East University*

*(External Committee Member)*

**Dr. Khair Eddin M. Sabri**

*Associate Professor, Department of Computer Science*

*The University of Jordan*

## **Acknowledgement**

First, I give thanks, praise to Allah for his mercy, and reconcile and for granting me knowledge, confidence, patience to pass this Master thesis successfully.

Also, I owe a great gratitude for those who inspired me throughout this venture to express my thank to my thesis advisor. Dr. Hesham Abusaimh for the complete guidance throughout the thesis stages, and for the critical assistance in designing and proceeding the methodology of my research. I would also like to express my appreciation to the Middle East University and Department of Computer Science where I spent great times.

Finally, I thank all those, who have helped me directly or indirectly in the successful completion of my research work.

**Ahmad Mahafzah**

**The Researcher**

## Dedication

Every challenging work needs self-efforts as well as the guidance of older especially those who were very close to our heart.

This study dedicated to my whole family and friends;

My Father, who always proud of me and supported me in every step of my life and encouraging me believed in myself, thank you for everything

My Mother, no words can describe what you have done for me, thank you for your endless love.

My sweetest brothers and sister, who are one part of my life.

I would also like to dedicate this thesis to the spirit of My Grandfather who is my first teacher.

My friends who always been there for me during difficult and stressful times, particularly, Khaled Alawneh.

It is hard to find a word to express my gratitude and thanks, to each of the above, I extend my deepest appreciation.

**Ahmad Mahafzah**

## Table of Contents

Title .....	I
Authorization .....	II
Examination Committee Decision .....	III
Acknowledgment .....	IV
Dedication .....	V
Table of Contents .....	VI
List of Tables .....	VI
List of Figures .....	IX
List of Abbreviations.....	X
English Abstract .....	XI
Arabic Abstract.....	XII
<b>CHAPTER ONE: INTRODUCTION</b>	
1.1 Introduction .....	2
1.2 Wireless Sensor Network Based on ZigBee .....	4
1.3 Localization and Tracking Overview .....	7
1.4 Problem Statement.....	9
1.5 Research Questions.....	10
1.6 Aim and Objectives.....	11
1.7 Contribution and Significance of the Research.....	11
1.8 Scope of the Study.....	12
1.9 Thesis Outline .....	12
<b>CHAPTER TWO: BACKGROUND AND LITERATURE REVIEW</b>	
2.1 Overview.....	15
2.2 Literature Review.....	15
2.3 Summary.....	21
<b>CHAPTER THREE :METHODULEGY AND THE PROPOSED MODULE</b>	
3.1 Introduction .....	24
3.2 The Proposed System .....	25
<b>CHAPTER FOUR: IMPLENTATION AND RESULTS</b>	
4.1 System Assumption.....	37
4.2 SimulationScenarios.....	38
4.3 The Performance Evaluation of Proposed Method .....	41
4.4 Evaluation Metric .....	44
4.5 Result Analysis .....	46
4.5.1 Comparison of Tracking Error Of Existing And Proposed System.....	46
4.5.2 Comparison Of Tracking Throughput Of Existing And Proposed System.....	47
4.5.3 Comparison of Tracking Delay of Existing and Proposed System.....	48
4.5.4 Comparison of Tracking Packet Delivery Ratio of Existing and Proposed System.....	50
4.5.5 Comparison of Tracking Residual Energy of Existing and Proposed System.....	52
4.6 Performance Evaluation.....	54
<b>CHAPTER FIVE: CONCLUSION AND FUTURE WORK</b>	
5.1 Conclusion.....	56

5.2 Future Work.....	57
REFERENCES.....	58

**List of Tables**

<b>Chapter Number- Table Number</b>	<b>Contents</b>	<b>Page</b>
Table 4.1	proposed System Simulation Parameters	40
Table 4.2	Existing System Simulation Parameters	41
Table 4.3	Parameter's average of proposed and existing system.	54



## List of Figures

Chapter Number- Figure Number	Contents	Page
Figure 1.1	Sensor nodes scattered in a sensor field (Akyildiz and Vuran, 2010).	3
Figure 1.2	The components of Sensor Node (Sohraby, Daniel and Znati, 2007).	4
Figure 1.3	Types of Devices in ZigBee network.	5
Figure 1.4	The ZigBee and IEEE 802.15.4 Layer.	6
Figure 2.1	Classification of tracking technologies.	21
Figure 3.1	Simple indoor tracking architecture.	25
Figure 3.2	Flowchart of Proposed Methods.	27
Figure 3.3	Overview simple block diagram (pu,2009).	28
Figure 3.4	Overview 2D Trilateration approach example for three beacons.	32
Figure 3.5	Locations for Simplified Trilateration (Pu,2009).	33
Figure 4.1	Sensor and mobile nodes Deployment.	39
Figure 4.2	Sensor nodes, Mobile Nodes and Sink Node.	43
Figure 4.3	Energy level of sensor nodes.	44
Figure 4.4	Tracking Error of existing and proposed system.	47
Figure 4.5	Throughput of existing and proposed system	48
Figure 4.6	Delay of existing and proposed system.	50
Figure 4.7	Packet Delivery Ratio of existing and proposed system	52
Figure 4.8	Residual energy of existing and proposed system	53

## List of Abbreviations

ABBREVIATIONS	MEANING
ADC	Analog to Digital Convert
AODV	Adhoc on Demand Routing
CTA	Closer Tracking Algorithm
DSR	Dynamic Source Routing
LQI	Link Quality Indicator
MAC	Medium Access Control
MN	Mobile Nodes
PHY	Physical
PDR	Packet Delivery Ratio
QOS	Quality of Service
RSSI	Received Signal Strength Indicator
SN	Sensor Nodes
TDOA	Time Difference of Arrival
TOA	Time of Arrival
WLAN	Wireless Local Area Network
WPAN	Wireless Personal Area Networks
WSNS	Wireless Sensor Networks
ZC	ZigBee Coordinator
ZDO	ZigBee Device Object
ZED	ZigBee End Device
ZR	ZigBee Router

# **Optimizing Indoor Tracking System for Wireless Sensor Networks**

## **Using ZigBee**

### **Prepared By**

**Ahmad H. Mahafzah**

### **Supervisor**

**Dr. Hesham Abusaimh**

### **Abstract**

Recent evolution in wireless communications has developed Wireless Sensor Network (WSN), one of the essential applications in WSN is mobile object tracking. Tracking indoor objects is mainly finding the location of mobile objects when entering a certain area that is covered by WSN, while this kind of network has many limitations in power and memory. It is hard to find the accurate position of the mobile target.

In this thesis, we proposed a method to track mobile object inside a building that is covered with WSN implementing ZigBee standards. This proposed method is an enhancement for the Received Signal Strength Indicator (RSSI) that can consider the energy of the node in localization. In addition, this proposed method is used for finding the location of multiple mobile objects at the same time.

A performance result of this method has been measured and compared with the original RSSI method using NS-2 simulator. All the achieved simulation results have shown better performance for the proposed methods as compared to the original method. The Tracking Error improved by 8% and power consumption improved by 7%. Furthermore, the new network performance measurements have obtained a good value compared with the other measures in term of the network performance measurements such as packet delivery ratio (PDR), delay and throughput improved by 73%, 36% and 45%, respectively.

**Keywords: Wireless Sensor Networks, Received Signal Strength Indicator, ZigBee, Mobile Tracking, Energy Consumption, Location.**

## تحسين نظام تتبع داخلي لشبكات الاستشعار اللاسلكية باستخدام

### ZigBee

إعداد

احمد هاني محافظة

إشراف

الدكتور هشام ابو صايمة

### المُلخَص

التطور الأخير في الاتصالات اللاسلكية لتطوير شبكة الاستشعار اللاسلكية، واحد من التطبيقات الأساسية في شبكات الاستشعار اللاسلكية هو تتبع الأجسام المتحركة. إن تتبع الأشياء الداخلية يكشف بشكل أساسي موقع الأجسام المتحركة عند الدخول إلى منطقة معينة تغطيها شبكة الاستشعار اللاسلكية، في حين أن هذا النوع من الشبكات له العديد من القيود في الطاقة والذاكرة، سيكون من الصعب العثور على الموقع الدقيق لهدف الجوال.

في هذه الرسالة، اقترحنا طريقة لتعقب كائن متحرك داخل مبنى مغطى بشبكة الاستشعار اللاسلكية التي تنفذ معايير ZigBee. هذه الطريقة المقترحة هي تحسين لمؤشر قوة الإشارة المتلقاة التي يمكن أن تعتبر طاقة العقدة في التعريب. بالإضافة إلى ذلك، تُستخدم هذه الطريقة المقترحة للعثور على موقع كائنات متعددة متحركة في نفس الوقت.

تم قياس نتيجة أداء لهذه الطريقة ومقارنتها مع طريقة مؤشر قوة الإشارة المستلمة الأصلية باستخدام أداة المحاكاة NS-2. أظهرت جميع نتائج المحاكاة التي تم تحقيقها أداءً أفضل للطرق المقترحة مقارنة بالطرق الأصلية. تحسن خطأ التتبع بنسبة 8% واستهلاك الطاقة بنسبة 7%. علاوةً على ذلك، حصلت قياسات أداء الشبكة الجديدة على قيمة جيدة مقارنةً بالشبكة الموجودة من حيث قياسات أداء الشبكة مثل نسبة تسليم الحزم (PDR) والتأخير والإنتاجية المحسنة بنسبة 73% و36% و45% على التوالي.

الكلمات المفتاحية: شبكات الاستشعار اللاسلكية، مؤشر قوة الإشارة المتلقاة، زيغبي، تتبع المحمول، استهلاك الطاقة، الموقع.

# Chapter One

## Introduction

## 1.1 Introduction

Recent evolution in wireless communications and digital electronics facilitates the development of smart small sensor devices that have wireless communication and based on battery as power supply. In addition, these Wireless Sensor Networks (WSNs) are used to track mobile objects indoors as they are very cheap devices, and a huge number of these wireless devices should be used in any WSN. It can be defined as a specialized collection of sensors and actuators infrastructure used for wireless communications. It is scattered physically for over large area and used to transmit information to the communication control centre. WSN possess low execution price, avoids plenty of wiring.

The central element of a WSN is the wireless sensor node. These sensor nodes sense and process the information from the surrounding environment. These sensors also communicate with each other to exchange the data. All the communication in WSN is taken place between source and destination. The destination is called as a base station or sink. Sink node acts as a gateway or interface between the sensor field and to the user. In addition, they save the communication protocols and the data-processing algorithms to execute them when needed (Sohraby, Kazem, Daniel, and Znati, 2007).

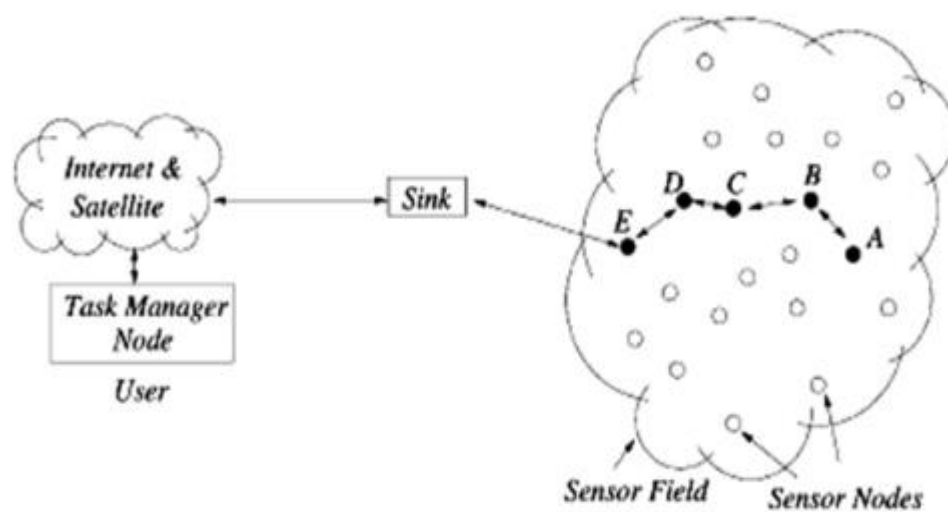

**Figure 1.1: Sensor nodes scattered in a sensor field (Akyildiz, Su, Sankara subramaniam, and Cayirci, 2002).**

The sensor nodes are usually scattered in a sensor field as shown Figure 1.1. Each of these scattered sensor nodes has the capability to collect data and route data back to the sink/base station and the end-users. Data are routed back to the end-user by a multi-hop infrastructure less architecture through the sink as shown in Figure 1.1 without any of these networks where the sink can be directly connected to the end-users.

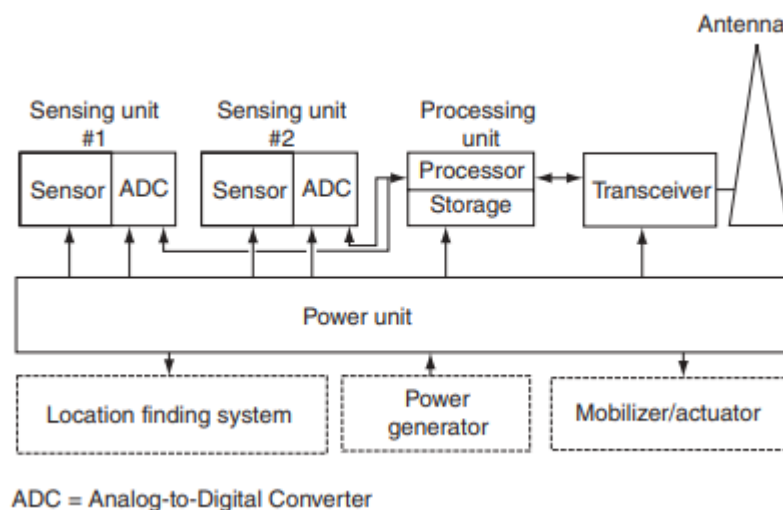

**Figure 1.2: The components of Sensor Node (Sohraby, Daniel, and Znati, 2007).**

Any sensor node consists of a sensors unit, a transceiver, a memory, a processor and a power unit as illustrated Figure 1.2 The sensor unit consists of one or more than one sensor to measure the environment properties. These sensors can be classified into different types including optical, infrared, acoustic, thermal, magnetic and biological sensors. The transceiver is used to transmit and receive data to and from the base station. the memory is small in its size so the data is sent to the base station because it has a large memory size. the processor is the central element used to schedule and execute the assigned sensing tasks. The essential power source is a battery but sometimes it is not enough so a secondary power supply may be added on the environment where the sensor nodes are deployed (Akyildiz and Vuran, 2010).

## 1.2 Wireless Sensor Network Based on ZigBee

The WSN is available to provide many services like indoor tracking mobile object through ZigBee network standard. ZigBee network provides remarkable communication protocols using low range and low-power digital radios based on standard IEEE 802.15.4 for Wireless



Personal Area Networks (WPANs). It is originally designed to provide short-range communication services that provides lower data rate. ZigBee is developed on the network and application layer in IEEE 802.15.4 standard. Topologies is considered as an acceptable three main of configuration, they are tree, star and mesh topologies. It is built on top of IEEE 802.15.4 standard, which defines the characteristics of the physical and Medium Access Control (MAC) layer on protocol stack for WPAN. Using this standard as a framework. The upper layer is defined by ZigBee Alliance (Abusaimh, and Yang, 2012).

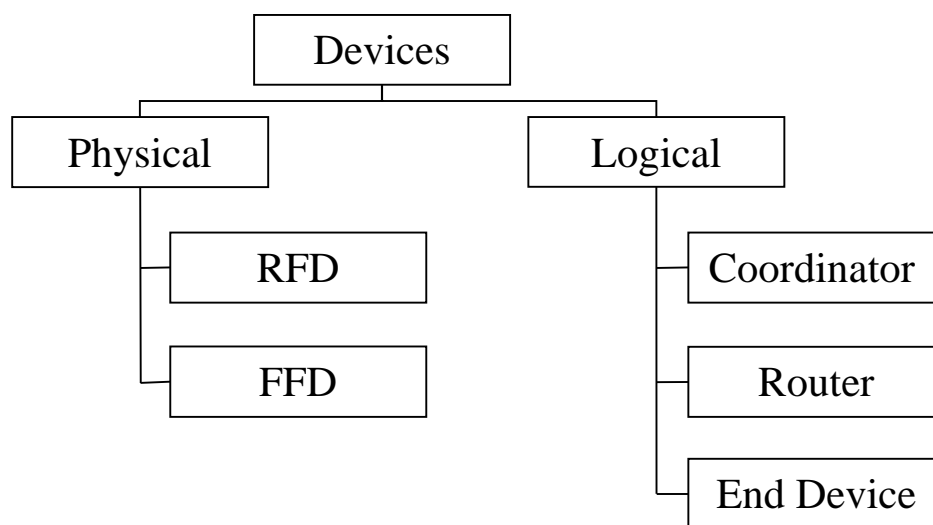

**Figure 1.3: Types of Devices in ZigBee network.**

ZigBee network devices are categorized as physical and logical. Figure 1.3Figure illustrated the brief classification of devices. The physical type devices can be also classified into two classes Full Function Device (FFD) and Reduced Functional Device (RFD). Any of the devices may operate as sensors control regardless of its type. FFD also performs the routing functions of a network. It can also have child devices so as to perform routing depending upon

its location in a network. It can be said further, that RFDs do not perform routing function hence, no child device can be there. Furthermore, this can be logical type devices classified into three types namely coordinator, router, and end device. Coordinator device are considered as the most capable device, that forms the core of the network. There should be exactly one ZigBee coordinator in a network to initiate the structure of a network. acting as a bridge to other networks. The ZigBee end devices have restricted functionality to communicate with a coordinator, or a router only, it cannot pass on data to other devices. This functionality of the end devices leads to a sleep state for a significant period, resulting in a long operating life (Abusaimh, and Yang, 2012).

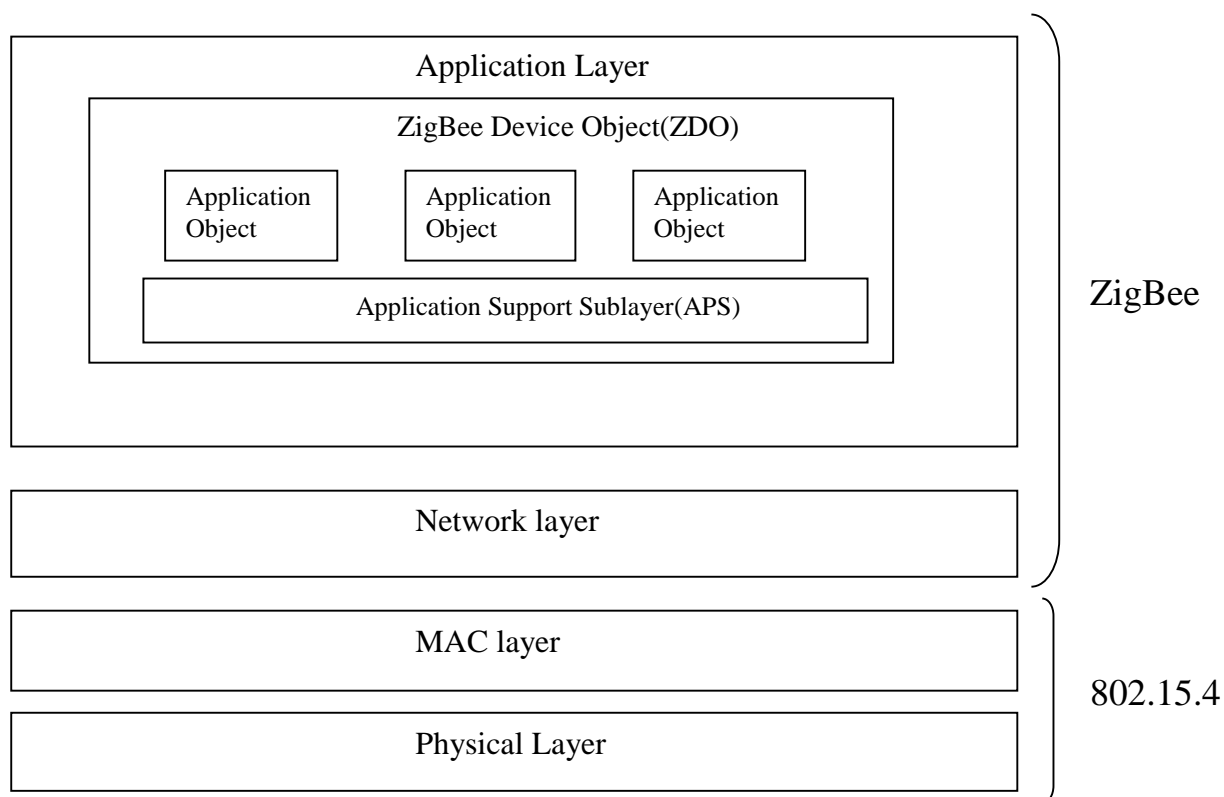

**Figure 1.4: The ZigBee and IEEE 802.15.4 Layer.**

The protocol stacks defined by the ZigBee Alliance with respect to IEEE 802.15.4 standard

protocol stacks are shown in Figure 1.4. The ZigBee architecture includes the Application Support (APS) sub-layer, ZigBee Device Object (ZDO), and user-defined application profile(s). Communication among the devices stored in tables which maintained by APS sublayer. These tables are used during discovery phase to discover the devices being operated in reference space. The ZDO determines the type of the device (i.e., coordinator or FFD or RFD) in a network. It also replies to binding requests while ensuring a safe connection between two devices. The user-defined application refers to the end device that conforms to the ZigBee Standard.

### **1.3 Localization and Tracking Overview**

Node localization is defined as determining the position of a sensor node in the concerned network area with respect to the origin. Localization techniques for WSN consist of the algorithms that estimate the locations of sensors with initially unknown position information normally using available information about the absolute positions of a few other sensors and position measurements. Sensors with known location information are called beacons or anchors. The anchors define the local coordinate system to which all other sensors are referred. The coordinates of the sensors with unknown location information also called blind or non-anchor nodes, it is estimated by various sensor network localization techniques. It is very common to classify the existing wireless localization techniques are classified according to the method of measurements; such as range-based or range-free. Generally, almost all the sensor network localization algorithms share three main phases distance estimation, position computation and localization algorithm. The distance estimation phase involves measurement techniques to estimate the relative distance between the nodes. The

measurement is basically performed by communication between two wireless nodes and about their connectivity proximity and their geometric relationship. The distance estimation process highly influences the accuracy and precision of localization. The most popular method in distance estimation for wireless systems is the Received Signal Strength Indicator (RSSI) technique (Yick Mukherjee, and Ghosal, 2008), which is based on the physical fact of wireless communication that theoretically, the signal strength is inversely proportional to the squared distance between the transmitter and receiver (Yang, 2014).

On the other hand, Tracking refers to know the location of moving object with time. The important function of a WSN is to collect and forward data to destination. It is very important to know about the position of collected data. Many challenges can affect the target tracking quality in wireless sensor networks such as node failure due to battery exhaustion. Some of the challenges are summarized below (Chen, Hou, and Sha, 2004; Yick, et al., 2008).

- Target missing/recovery: One of the major reasons of this issue is target reposition. To deal with this issue, robust tracking algorithms should be proposed to decrease the probability of missing targets. However, recovery mechanisms must take consideration of fact that target may be lost (Chen, Hou, and Sha, 2004).

Coverage and connectivity: The WSN coverage dedicates the number of sensor nodes to be deployed, the location of these sensors, energy and connectivity. The chances of this issue are more on mobile networks. High coverage results in high tracking accuracy. Therefore, the performance of tracking algorithms in outdoor scenarios degraded in case of high mobility of devices (Yick, et al., 2008).

- Data aggregation: Aggregation mechanism aims to eliminate data redundancy. In a clustered network, the nodes transfer their collected data to their associated cluster head, which

performs data aggregation and eliminates redundancies. So, the data aggregation should be proficient, with minimum data redundancy while preserving energy (Pino, Arroyo, and Cid, 2014).

- Tracking latency: the execution of target tracking algorithms must be performed rapidly while preserving positioning accuracy. When the operation of tracking takes too long, the moving node may change its location. This also arise issue of increased battery consumption so as to collect updated position information of devices under consideration (Pino, Arroyo, and Cid, 2014).

Tracking applications can be classified into two categories: remote monitoring and mobile object location tracking. Tracking objects have also great intention from the researchers and can be further divided into indoor and outdoor applications (Yang, 2014).

In the outdoor tracking, the Global Positioning System (GPS) is used depending on distributed satellites that present three-dimensional positioning. However, GPS is not working indoor because the signal does not pierce through the solid walls or structures, it is affected by large buildings or structures.

The importance of the object tracking concept appeared in many several areas such as public safety human tracking, Health patient tracking and monitoring, firefighter tracking and human tracking in a shopping mall and airports. In literature, many objects tracking algorithms and protocols have been presented by the researcher.

## 1.4 Problem Statement

One of the most challenging research areas in WSN is tracking mobile target, as a tracking issue is not the prime task of sensor networks. Therefore, it is demanded for light-weight

localization technique, as it is efficient and does not need any additional hardware, Therefore, tracking a target in a sensor networks have received great attention recently. A tracking algorithm designed for sensor networks should be: (1) accurate – it should work with high accuracy in different environments; (2) energy efficient - it should require little computation, especially in terms of communication; (3) robust – does rely on target movement and external noise; (4) reliable - it tolerates node failures. In this section, the tracking problem from two different aspects is discussed: localization accuracy and power consumption.

Due to energy limitation in WSN considered many research works to enhance the energy efficiency of different aspects of the networks. Three main consumers intention in WSN; signal processing, data transmission, and hardware operations. Consuming less energy in the tracking applications is of primary design concern of WSN application, as each sensor node requires battery support that is usually difficult to replace.

Energy conservation is another critical technical issue in developing sensor networks for object tracking applications. Thus, it represents a challenge for reducing the communication and power-consumption when using WSN. Hence, it is interesting to design and implement an RSSI based localization solution for indoor tracking applications, and so it is important to investigate energy-efficient approaches for tracking problems using WSN's. The proposed algorithm in this thesis is investigating movement with the sensors movements, which implies a strong constraint on the algorithm calculation time.

## 1.5 Research Questions

The proposed work in this thesis is supposed to answer the following questions:

1. What is the architecture of the proposed model?

2. How can we detect the location of multi mobiles at the same time?
3. What quality attributes the proposed system considers?
4. How to measure and prove the performance of the proposed methods considers?
5. Which parameters can be selected for best performance?
6. What are the main enhancements and weaknesses of the proposed architecture?

## 1.6 Aim and Objectives

The main aim of this study is focusing on indoor tracking techniques using ZigBee to make it more accurate and reduce the power consumption of the wireless sensor nodes. This enhancement on accuracy and power will have a direct effect on tracking real objects in a real-time application such as tracking indoor firefighting, public safety human tracking, Health patient tracking, etc. The objectives of this research can be summarized as follows:

1. Study and configure WSN based on ZigBee using Network Simulator(NS-2).
2. Implement RSSI, an indoor tracking method to track position of wireless nodes in the network and Improving the accuracy of finding the coordination of the mobile object.
3. Considering power consumption via wireless nodes during tracking location. without effective any of the network performance parameters such as delay, throughput, packet delivery ratio. Propose energy efficient tracking solution for WSN to reduce the power consumption required for tracking applications

## 1.7 Contribution and Significance of the Research

This thesis provides a proposed mechanism to calculate and find a location of multiple mobile objects at the same time simultaneously in a wireless sensor network based on

ZigBee without effective any of network performance measurements such as delay, throughput, PDR, and energy consumption.

Two main contribution is achieved hence, namely Localization accuracy which is to be improved for RSSI based system through a trilateration-based approach, a ZigBee based tracking approach in order to achieve. Reasonable localization accuracy for tracking multiple mobile targets for offering low power consumption, as it is implemented using the full roles for ZigBee network standard.

## 1.8 Scope of the Study

This study discusses the localization techniques of multiple mobile objects based on random mobility tracks inside fixed indoor WSN based on ZigBee standards that reduce the energy consumption of the network and increase the accuracy of finding the location. This location technique will help in application for public safety human tracking, Health patient tracking and monitoring, firefighter tracking and human tracking in a shopping mall and airports.

## 1.9 Thesis Outline

This chapter introduction of wireless sensor network in general and provided an overview of localization and tracking. Finally, the research problem, aim and objectives, contribution and significance of the research and scope are also discussed. The rest of this thesis is organized as follows:

**Chapter Two** discusses previous studies on mobile tracking an explain the closest works to our proposed algorithm.

**Chapter Three** shows in details a description of the proposed algorithms.



**Chapter Four** details a complete discussion of the simulation scenarios and the results of the proposed algorithms.

**Chapter Five** includes conclusions from the experimental analysis and future work.

# **Chapter Two**

## **Background and Literature**

### **Review**

This chapter is intended to illustrate literature review section on WSN. The literature reviewed in this section outlines the possible methods, techniques, and technologies used in ZigBee Network to track target location and finally displays the summary of this chapter.

## 2.1 Overview

Recently, there are many investigations and researches related to use of ZigBee in indoor tracking systems for WSN have been done, where the use of ZigBee protocol makes the user able to transmit various data type from place to another with low cost and power. But, there are not sufficient simulation-based performance evaluations of the new standard. In this chapter, some of the developed studies will be discussed.

## 2.2 Literature Review

Chen, Yang, Chang, and Chu, ( 2006) presented a survey with reference to RSSI solutions on indoor localization and proposed a Closer Tracking Algorithm (CTA) to locate a mobile user in the house. The proposed CTA was implemented by using ZigBee CC2431 modules. The experimental results show that the proposed CTA can accurately determine the position with error distance less than one meter. The proposed CTA shows at least 85% precision when the distance is less than one meter.

Tadakamadla, (2006) described a model for monitoring the presence and movements of vehicles and humans in an indoor environment. Author tagged vehicles/humans with a ZigBee node and deployed a number of nodes at fixed position in the room; the RSSI is used to determine the position of tagged object. Configured System operated by recording and processing signal strength data at multiple base stations located to provide information in the area of interest. It combines Euclidean distance technique with signal strength matrix obtained

during offline measurement to determine the location of user. The experimental results presented the ability of system to estimate user's location with a high degree of accuracy.

Ferrari, Medagliani, Di Piazza and Martalò, (2007) studied the performance of WSN in an indoor environment. The majority of networks have been formed through nodes utilizing ZigBee. Also, networks have been analyzed according to the proprietary standard Z-Wave in order to be compared. Authors proposed two network scenarios. First scenario involved direct transmissions between the coordinator of network and remote nodes and the second scenario includes transmitting the packets between the coordinator and the remote nodes. The behaviour of the network is categorized based on throughput as well as end-to-end delay.

Alhmiedat, (2009) proposed a decentralized ZigBee-based tracking system to detect and track the location of mobile nodes indoors based on the received signal strength (RSS). The proposed tracking system is a range-free system, which does not require additional hardware, depends on a new weight function, and can be deployed wherever the node density is low. The authors used ZigBee sensor devices, and they evaluated the proposed tracking system based on accuracy and communication cost. ZigBee networks benefit from having the ability to quickly attach information, detach, and go to sleep mode, which offers low power consumption and extended battery life. They also explored the RF-based localization techniques and other localization techniques which are based on measuring the weights in order to calculate the position of the target nodes. A new weight function is introduced, which is based on the distance between beacon nodes and the RSS values of them. The RSS system in combination with a weighted function offers lower communication overhead and lower localization complexity. The localization accuracy has been improved based on the collected weights from beacon nodes. The weight function can eliminate the effect of the environment's characteristics and consequently helps in more accurately estimating the position for the target

nodes.

Larranaga, Muguira, Lopez-Garde and Vazquez,(2010) discussed different environmental factors that affect the RSSI values measured to calculate the position of the device. The proposed system consists of two main phases: calibration and localization. The use of a central processing server allows the implementation of complex algorithms, while the ZigBee network allows collecting signal level values and at the same time, it is used to provide data to the central server for localization computation. To locate blind nod the system performs the calibration, so that changes in the environment are taken into account in the localization phase, and thus making the system more robust and accurate. The system has been deployed in Deustotech facilities, which is a real environment with different separate furnished rooms. Results show that system locates the location of nodes with minimum absolute error.

Chu et al., (2011) introduced two methods to improve the accuracy of ZigBee positioning and implemented an indoor personnel tracking system. Two methods are Neighbor Area Majority Vote Priority Correction and Environment Parameter Correction proposed to promote the accuracy of ZigBee positioning. The experiment results demonstrate that proposed methods can largely increase accuracy of ZigBee positioning and provide useful personnel tracking technology.

Chandane, (2012) analyzed performance of IEEE 802.15.4 using Qualnet 4.5. Author designed star topology, multi-hop peer to peer network. MANET routing protocols such as AODV, DSR and DYMO are used for analysis of Quality of Service (QoS) parameters like throughput, packet delivery ratio, average end-to-end delay, jitter, total energy consumption, and network scalability as the performance metrics. Results show that AODV outperforms other two in star topology whereas DSR has slightly upper hand in multi-hop topology for varying traffic loads, and in beacon-enabled mode.

Xiong et al., (2013) briefly explained IEEE 802.15.4 based WSN positioning systems and RFID positioning systems and its limitations. Author introduced positioning system via combining WSN and RFID in order to compensate the limitations of each technology and proposed Hybrid cooperative positioning algorithm based on Kalman filter (KF). Proposed tracking system was first evaluated through simulations and then by means of real experiment deployment. Results indicated that KF based positioning solution is capable to increase the robustness and accuracy of indoor positioning systems in harsh propagation conditions.

Alhmiedat, Samara, And Abu Salem, (2013) suggest a fingerprinting localization system according to an RSS technique. The implemented approach is based on dividing the tracking area into subareas and assigning a unique feature to each subarea through ranging the RSS values from different reference points. In order to test the proposed system's efficiency, a number of real experiments were conducted utilizing Jennic sensor nodes.

(Obaid, Abou-Elnour, Rehan, Saleh, and Tarique, 2014) briefly explained a overview of ZigBee technology and its application in wireless home automation systems. The performances of the ZigBee based systems have also been compared with those of other competing technologies-based systems. In addition, some future opportunities and challenges of the ZigBee based systems have been listed.

Oracevic, and Ozdemir, (2014) targeted different target tracking methods via focusing on security. Author explained the important protocols in each category and described which security properties they provide. Paper presented that most of the research in target tracking focused on the accuracy or energy efficiency and there is limited amount of work that considers security. Author presented a table that summarizes the state of the art in the target tracking area. Open research issues also addressed in paper.

The study in (Vancin, and Erdem, 2015) utilizes the IEEE 802.15.4/ZigBee, which has

advantages than other types of technology with respect to parameters such as; use of the battery in addition to low consumption of power. In this study, OPNET simulator is used to achieve the required results. The behaviour of mobile node and network fixed has been compared based on the quality of the end-to-end delay parameters and traffic received through the destination.

Jia, Wu, Li, Zhang, and Guan, (2015) addressed a series of possible schemes for localization, which solves three crucial problems: the self-localization of beacons, the calibration of beacons after self-localization and positioning and tracking the mobile target in three dimension settings by beacons. Aimed at these three problems, Author proposed the weighted least squares estimation of localization for self-localization of beacons, which minimizes the influence from measurement errors by means of DSA (Differential Sensitivity Analysis). Author then addressed problem of accuracy and employed the calibration scheme for beacons with the aid of the mobile robot. Then, after comparing the EKF (extended Kalman filter), HF and STF (Strong Tracking Filter) methods, author concluded that HF has the best adaptiveness to the uncertain state model, and STF has the best tracking performance to the system with great disturbance. Paper also presented analyses of attributes of the Gauss-Newton iterative method and the Cayley–Manger determinant. Lastly, the simulation and experiment are used for evaluating the proposed methods, and the consequences show that the methods are feasible for localization in 3D settings and have high localization accuracy.

Ghumare, (2015) discussed the importance of target tracking in wireless sensor network. Author simulated network using LEACH (Low Energy Adaptive Cluster Hierarchy) a energy saving algorithm. Paper explains the difference between two techniques range based and range free techniques for localization. Author used range-free localization which is known to be of low cost and requires minimum hardware. LEACH algorithm with prediction

technique is used for the long life of the network. Author addressed the packet delivery ratio problem in wireless sensor network.

Shinde, Panchal and Panchal, (2016) discussed limitations of some previous location tracking techniques and presented a low-cost approach for indoor location positioning system to track location of mobile object in indoor environment. Author proposed a Location fingerprinting method which includes two phases (a) Training or Calibration phase (b) Estimation phase. Mesh networking is used as it has capability to make ZigBee network more scalable and helps to increase the coverage area of location positioning system. Author discussed that kind of low-cost indoor location positioning system can be deployed in schools for keeping a track of children within school premises or to ping teacher remotely or in hospitals to ping a doctor in case of emergency.

Gifty, and Sumathi, (2016) analyzed performance of configured ZigBee network as three main topologies i.e. star, tree and mesh topology with varying traffic load. Author-focused to have low power consumption and high channel utilization. Impact of MAC parameters such as beacon order (BO) and super frame order (SO) for star, tree and mesh topology in beacon disable mode and beacon enable mode by varying CBR traffic loads is also analyzed. The reactive protocol Adhoc on- Demand Routing (AODV) and DSR (Dynamic Source Routing) comparison is performed on each topology. Performance parameters analyzed by author are Average jitter, Average end-to-end delay and throughput. Furthermore, the energy model comparison analysis for ZigBee WSN on Energy Consumption in transmit mode, receive mode, and idle mode is also analyzed.



## 2.3 Summary

In this chapter, several studies that are related to localization methods used to estimate the final coordinates of a mobile target's coordinates were reviewed, described, analyzed, and summarized. Figure 2.1 show the classification of tracking technologies.

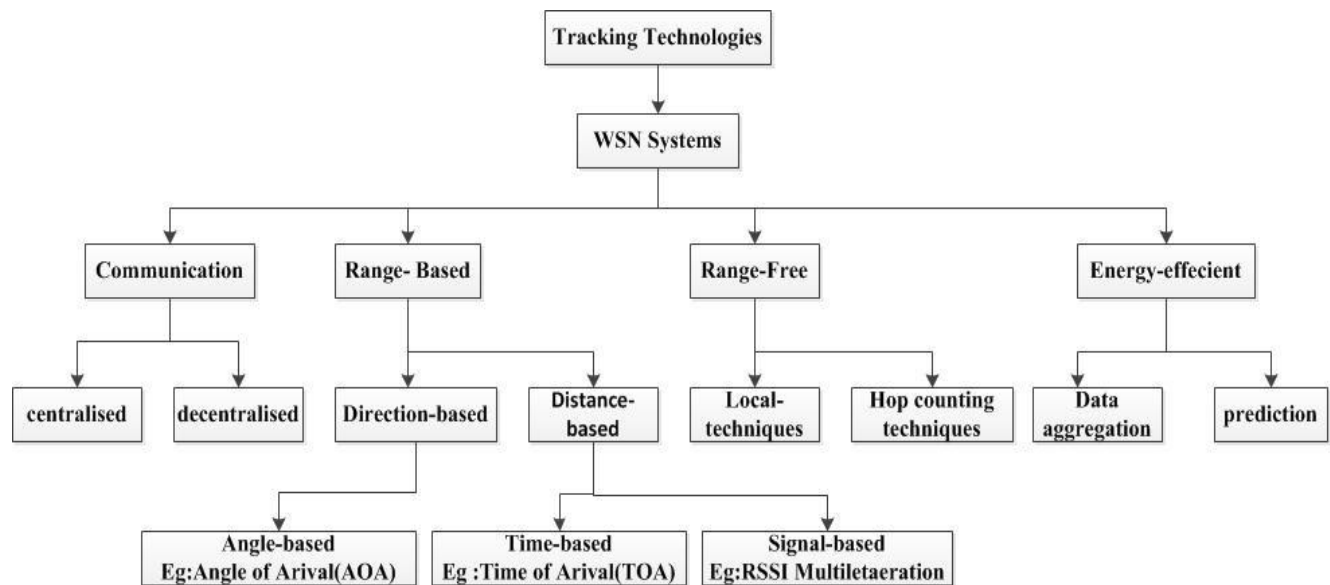

**Figure 2.1: Classification of tracking technologies.**

Localization algorithms require a distance to estimate the position of unknown devices. namely four possible ways to acquire a distance: received signal strength indicator (RSSI), link quality indicator (LQI), time of arrival (ToA), and time difference of arrival (TDoA). each including one or more localization methods. A localization method is a way which can be applied to compute the final coordinates of a mobile target node. With regard to the mechanisms used for estimating location, these localization protocols are classified into two categories: range-based methods and range-free methods.

The latter makes no assumption about the availability or validity of such information.

Because of the hardware limitations of WSNs devices, solutions in range-free localization are being pursued as a cost-effective alternative to more expensive range-based approaches. With regard to where localization computation actually occurs, these localization protocols can be classified as centralized and decentralized methods. These approaches are shown in Figure categorized into three main categories: Satellite, WSN, and Mobile Network based tracking systems.

# **Chapter Three**

## **Methodology and the Proposed**

### **Model**

This chapter presents the proposed model, which is developing a new descriptor based on tracking of indoor objects in Wireless Sensor Network (WSN) based on ZigBee

### 3.1 Introduction

This model depends on the RSSI received from nearby fixed position ZigBee sensor nodes installed inside the building and all mobile objects should be equipped with WSN ZigBee. Each sensor node has a location coordinates and in a network that includes mobile nodes and sink node. For each beacon node, the MAC address with its current location was registered and stored them in a Database. This data has to be available to the base station, in order to calculate the position of the mobile object node.

To fulfil the requirements of a wireless network, it also requires a Base Station, typically with higher frequency, processing power, computational power, range, battery power and so on. It is the extended version of typical sensor nodes with extra capability and responsibility to perform, on behalf of the administrators. The primary function of the base station is to collect the gathered data from sensor nodes and analyze it further to get the results for further actions. The base station also uses to control the sensor nodes by sending them additional configuration information, sometimes used to build the routing table but not in all the cases. The base is the intermediate link between the server and sensor nodes (or router). It collects the data from routers and passes it down to the server where wider analysis of data can be performed by the experts. In proposed work, mobile nodes send the data bytes to the base station and after collecting all the data it will pass it to the administrator. Nodes are deployed randomly with a single base station. Figure 3.1 represents the design in which the proposed method can be used.

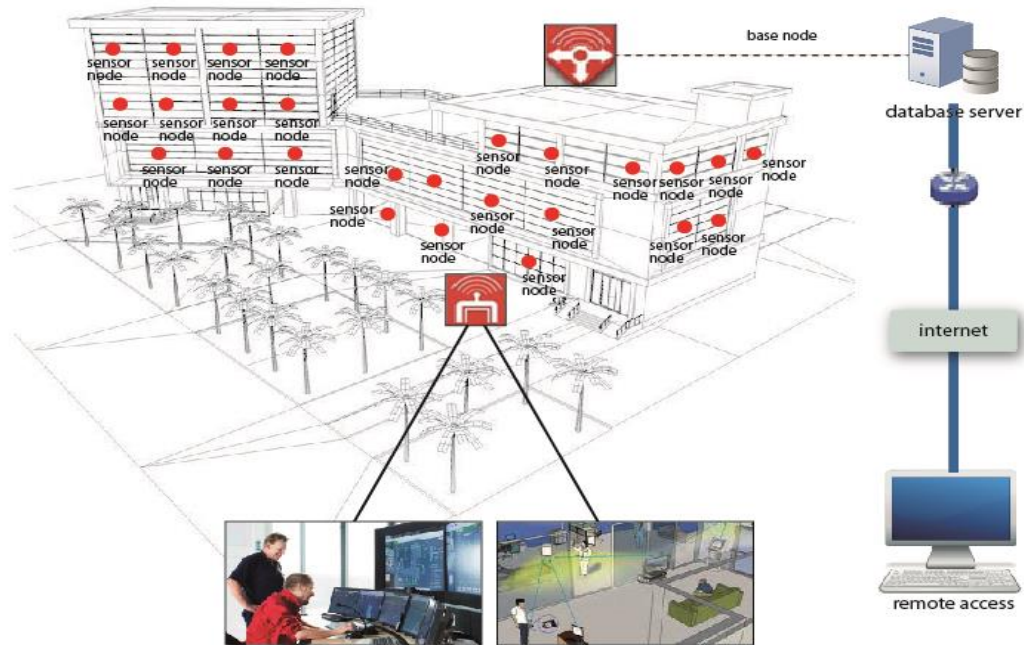

Figure 3.1: Simple indoor tracking architecture.

## 3.2 The Proposed System

As shown in Figure 3.2 the flowchart of tracking object should go over these steps.

Step1: Install and deployment of WSN in building.

Step 2: Detection mobile object equipped with wireless sensor node.

Step2.1: Detect mobile object by knowing the new devices in the network.

Step 2.2: These new devices should send the RSSI that are received from the fixed node in the network.

Step2.3: Base station calculates the location of each new mobile device in the network using Trilateration methods (Cook, 2005).

Step2.4: All new device sends the RSSI received fixed periodically to the base station.

Step2.5: Base station periodically update location of all new device.

Step3: On movement detect new fixed model.

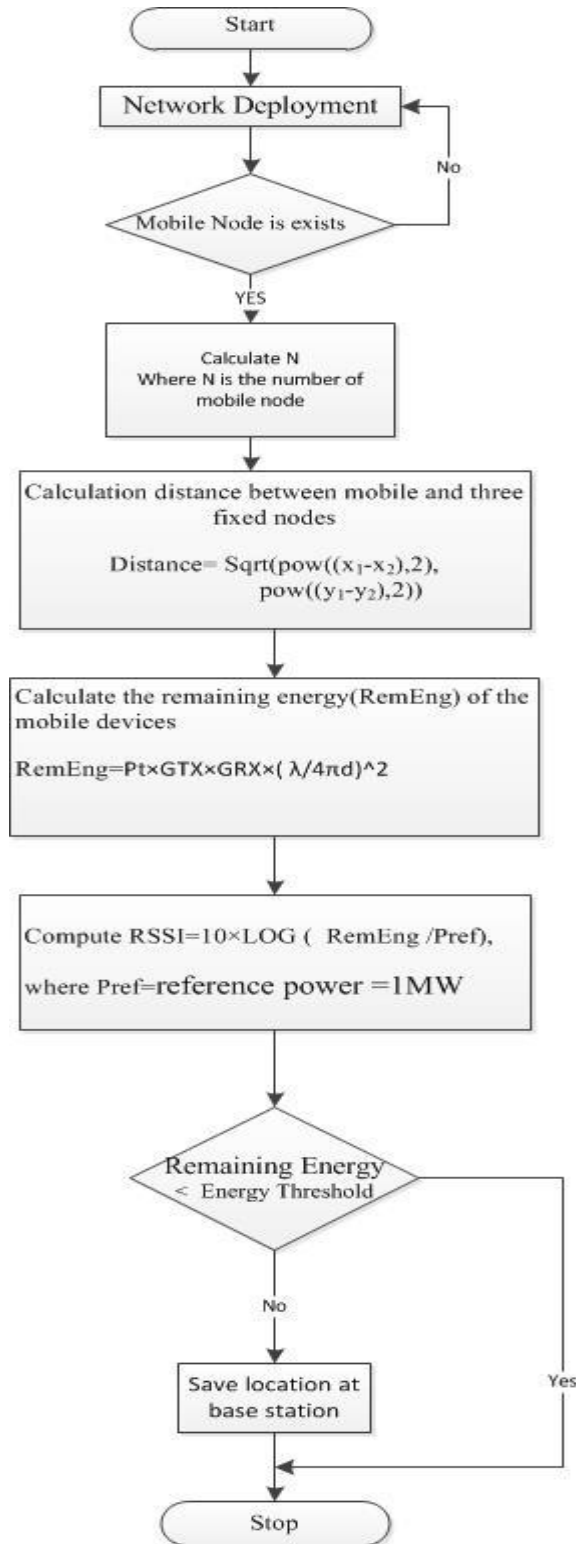

**Figure 3.2: Flowchart of Proposed Methods.**

The flowchart in Figure 3.2 describes the robust scenario of proposed work. This shows the

deployment of sensor nodes, mobile nodes and sink node. The proposed model uses the localization and distance techniques to get the exact location and distance among them and storing the location coordinates and distance into a trace file. These two tables are used to send the data from mobile nodes to sink node. As the range of sensor nodes is very low i.e. approximately 30 meters, so it is very difficult for them to transfer data directly to sink node. So, to transfer the data uninterruptedly, they use the nearby sensor nodes as intermediates and send it. Now sink node has the sensed data of network and the location of nodes that is stored in different tables.

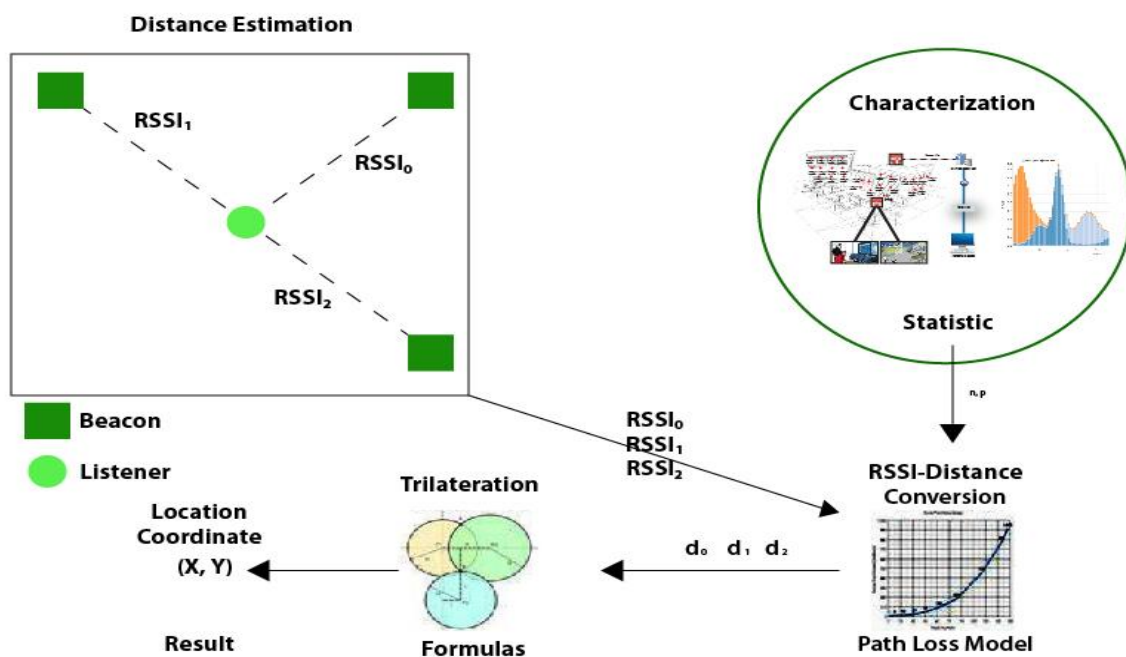

Figure 3.3: Overview simple block diagram(*pu,2009*).

An overview of the proposed system is presented we need to consider how to find the location coordinate from raw RSSI data in a block diagram as shown in Figure 3.3



The physical position of the sensor is identified by the term location of the WSN. It is of great importance for most in WSN applications as data measured is of no meaning if the actual location is not known (Yang, 2014).

WSNs localization and tracking algorithms are used to estimate the location of sensor nodes in the network by using the known location of few specific nodes called beacon nodes or reference points, which can obtain their absolute positions by their placement at points with a known location. The Received Signal Strength Indicator (RSSI) and Link Quality Indicator (LQI) are used to locate the distance between the sensor and beacon nodes.

Localization algorithms require a distance to estimate the position of unknown devices. This section introduces four possible ways to acquire a distance: RSSI, Link Quality Indicator (LQI), Time of Arrival (ToA), and Time Difference of Arrival (TDoA) (Blumenthal et al. 2007).

In our model, each node can adjust its transmission power and reception power individually based on its remaining and initial energy. We reduced the transmission power and the reception power based on the following mathematical formulas (Abusaimh, and Yang, 2009):

$$Pr = PrInit \times \frac{RemEng}{InitEng} \quad (3.1)$$

$$Pt = PtInit \times \frac{RemEng}{InitEng} \quad (3.2)$$

Where  $Pr$  is the reception power,  $Pt$  is the transmission power,  $PrInit$  is the initial reception power,  $RemEng$  is the remaining energy of the node, and  $InitEng$  is the initial full energy of

the node.

We calculate the remaining energy of the node based on our energy model in. However, this proposed technique attempts to reduce the transmission power and the reception power until reaching the minimum power, which is required to transmit the packet between two nodes in a certain distance. The relationship between the transmission power, the received power and the distance can be found from the 3.1 and 3.2 formula.

One possibility to acquire a distance is measuring the Received Signal Strength (RSS) of the incoming radio signal. The idea behind RSS is that the configured transmission power at the transmitting device  $P_{tInit}$  directly affects the receiving power of the receiving device  $P_{rInit}$ . According to transmission equation (Abusaimh, Shkoukani, and Alshrouf, 2014), the detected signal strength decreases quadratically with the distance to the sender. Received power can be expressed as in Equations ( 3.3 ).

$$\text{RemEng} = P_t \times G_{TX} \times G_{RX} \left( \frac{\lambda}{4\pi d} \right)^2 \quad (3.3)$$

Where  $P_t$  *Transmission energy of sender.*

$\text{RemEng}$  *Remaining energy of wave at receiver.*

$G_{TX}$  *Gain of transmitter.*

$G_{RX}$  *Gain of receiver.*

$\lambda$  *Wavelength.*

$d$  *Distance between transmitter and receiver.*

$n$  *signal propagation constant also named propagation exponent.*

The distance between the mobile node and fixed node we use Euclidian distance formula to calculate the distance as show in equation 3.4:

$$d = \sqrt{(X2 - X1)^2 + (Y2 - Y1)^2} \quad (3.4)$$

Where (X1, X2) and (Y1, Y2) point refers to the mobile node and fixed node location respectively.

In embedded devices, the received signal strength is converted to a received signal strength indicator (RSSI) which is expressed as the ratio of the received power to reference power (PRef). Typically, the reference power represents the absolute value of PRef = 1 mW.as shown in equation (3.2). (pu,2009).

$$RSSI = 10 \times \text{LOG} \frac{\text{RemEng}}{\text{PRef}} , [RSS = \text{dBm}] \quad (3.5)$$

According to equation (3.3) and (3.5), there exists an exponential relation between the strength of a signal sent out by a radio and the distance the signal travels. In reality, this correlation has proven to be less perfect, but it still exists. The reason is that the effective radio-signal propagation properties differ from the perfect theoretical relation that is assumed in the algorithm. The effects noted above such as reflections, fading, and multipath effects can significantly influence the effective signal propagation.

RSSI based localization systems are more competitive in terms of both accuracy and cost compared to other localization systems. It does not require a large DB and a long training phase; this decreases the size and computational burden of the DB.

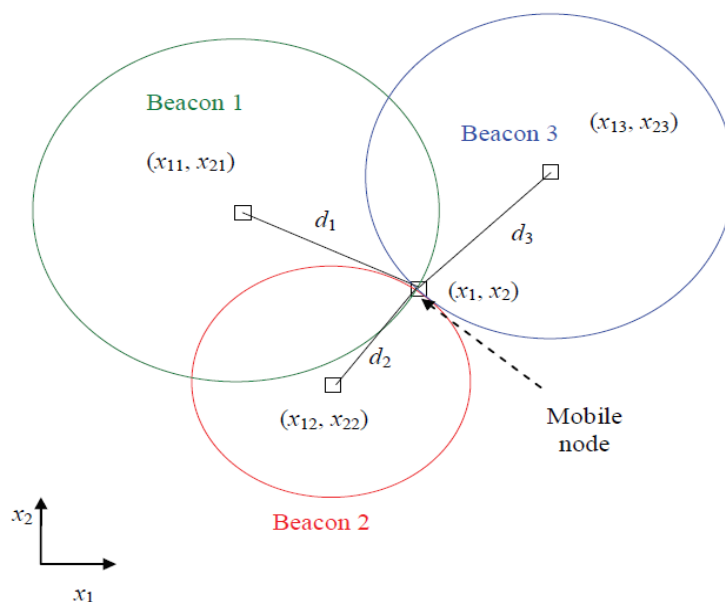

**Figure 3.4: Overview 2D Trilateration approach example for three beacons.**

The geometry of spheres or circles determines the real physical location of the object point for the trilateration methods. Figure 3.4 shows that the unknown object location is determined the distance measurements from 3 non-collinear points for 2D space. Knowledge of radius 1, radius 2, and radius 3 between transmitting and receiving point defines the  $(x,y)$  coordinates of the object point X.

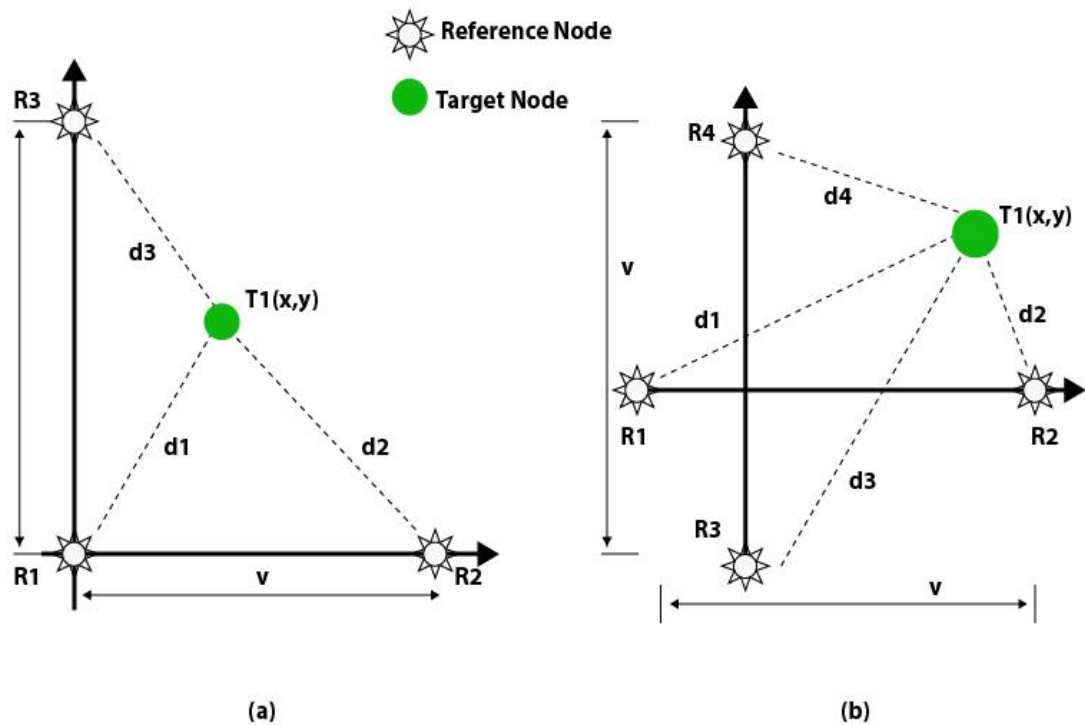

**Figure 3.5: Locations for Simplified Trilateration(Pu,2009)**

In Figure 3.5, three reference nodes are randomly allocated. An object node (mobile node) is moving around the reference nodes. The object node ( $T1$ ) can be located using the coordinates of the reference nodes ( $R1$ ,  $R2$ , and  $R3$ ) and the distances ( $d1$ ,  $d2$ ,  $d3$ ) between the reference nodes and the object node.

Figure 3.5, this is used by the mobile nodes to fetch the coordinates of different sensor nodes to build the location table and based on the coordinates stored in the location table a novel distance table is created that stored the distance between mobile nodes and the sensor nodes. There are multiple ways available to do compute the distance but the prominent solution for distance computation can be achieved using Pythagorean Theorem as shown in the following

expressions (Pu, 2011):

$$d1^2 = (x1 - x)^2 + (y1 - y)^2 \quad (3.6)$$

$$d2^2 = (x2 - x)^2 + (y2 - y)^2$$

$$d3^2 = (x3 - x)^2 + (y3 - y)^2$$

Rearrange the equations in (3.6) and solve for  $x$  and  $y$ , the location coordinates of the object node can be obtained as shown in the following expressions

$$X = \frac{AY32 + BY13 + CY21}{2(x1 \times Y32 + x2 \times Y13 + x3 \times Y21)} \quad (3.7)$$

$$Y = \frac{AX32 + BX13 + CX21}{2(y1 \times X32 + y2 \times X13 + y3 \times X21)}$$

Localization using equation (3.7) is very convenient because the distances ( $d1$ ,  $d2$ ,  $d3$ ) can be obtained from range, and the location coordinates of all reference nodes are previously stored in sensor nodes. The network maintains the location and distance tables that are accessible by all the sensor nodes deployed in the network. This will help them to fetch the location and distance between sensor nodes and mobile nodes. This process will help them to decrease the computational time and execution time. The reason behind maintaining the two new table are limited battery power of sensor nodes and limited computational power.

At the moment, a broad range of simulation environments are available to test WSNs, however, further research is required to check their reliability and accuracy. Currently, NS-2 presents one of the widely adopted simulation networking environments applied in assessing big networks. This fact triggered us to work with NS-2 in conducting our research, to test the

reliability and accuracy of this particular product, to estimate and compare the results in real life implementation with simulation outcome. Presumably, currently performed study basically provides the opportunity to cover the capacity of large-scale ZigBee wireless sensor networks in NS-2 simulation software.

# **Chapter Four**

## **Simulation Results and**

### **Discussion**



This chapter explains the performance of the suggested approach using an extensive simulation. Before analyzing the simulation results, the accredited performance metrics and the simulation environment are presented. Finally, we will compare our model to other related approaches that already exist to approve its superiority over them.

## 4.1 System Assumption

The assumptions that are stated about the network model in our algorithm are presented below. It is important to that these assumptions should be met to mention achieve the desired performance:

1. The WSN is composed of one sink node located in the center of the network and a large number of sensors that are distributed uniformly over a square grid.
2. Every sensor node in the network is aware of their location's coordinates.
3. The sensor nodes can detect multiple targets at a time.
4. All the sensor nodes have the same initial energy: homogeneous and stationary.
5. All the sensor nodes have the same action, sensing and processing capabilities.
6. After network deployment, the sensor nodes cannot be recharged.
7. All the sensor nodes are bi-directional.
8. The target moves through the network in a random way.
9. The target type that we want to track is a mobile target.

## 4.2 Simulation Scenarios

The proposed model has been implemented using Network Simulator version 2.35 (NS2) ([www.isi.edu/nsnam/ns](http://www.isi.edu/nsnam/ns)). NS2 is a software tool for computer network simulation. It is essentially elaborated with ideas of object design, code reuse and modularity. It is now reference standard in this field and several research laboratories recommend its use to test the new protocols. The current NS simulator is particularly well suited for packet-switched networks and large-size simulation. It contains the functionalities needed to study unicast or multicast routing algorithms, transport protocols, session, reservation, integrated services, application protocols such as FTP.

The proposed model of Wireless Sensor Networks is implemented using ZigBee which has 52 sensor nodes where nodes ranging from 0 to 44 are Sensor Nodes (SN), 6 are Mobile Nodes (MN) from node number 45 to 50 and 1 Base Station. The Base station is programmed as the sink node and during the simulation, a specific mobile node will be selected as source nodes to communicate with sink node through others sensor node. These nodes can do the sensing, location perform multi-task like gathering information of nodes (location, energy etc.), and packet transferring. There are two types of mobility available, the first one, which is moving from left to right and the other is in opposite direction. In scenario 1, nodes move from left to right in the simulation architecture, and it has the Base Station located with node number 51. Scenario 2, mobile nodes have to use the sensor nodes as the intermediate nodes to transfer their data to sink node. The node number 45, 46 and 47 are programmed and labelled as mobile nodes with higher energy than the sensor nodes in scenario 1 and mobile nodes number 48, 49 and 50 respectively for scenario 2. Every sensor node has the

transmission range of 30 meters which means that they can transmit sensed data within the 30 meters but can't exceed it. If they try to exceed their limits the packets will be dropped. Sensor nodes can make the routing path based on their range and the mobility of nodes where sensor nodes are fixed and can be used for data transmission only.

Figure 4.1 is the basic scenario of randomly deployed sensor nodes, mobile nodes and sink node. The screenshot is captured at 0.0 seconds that shows the actual position of everything.



**Figure 4.1: Sensor and mobile nodes Deployment.**

The simulation parameter that are used during all conducted simulation experiments are

presented in Table 4.1. Unless otherwise stated in the thesis.

**Table 4.1: proposed System Simulation Parameters**

Serial No.	Parameter Name	Parameter Value
1.	Area of flat grid	400m*400m
2.	No. of sensor nodes	45
3.	No. of mobile nodes	6
4.	No. of base station	1
5.	MAC Layer protocol	MAC/802.15.4
6.	Simulation time	100 s
7.	Antenna type	<i>OmniAntenna</i>
8.	Radio model	<i>TowRayGround</i>
9.	Transmission range	30m
10.	Routing protocol	AODV
11.	energy model	100 Joules
12.	T <sub>x</sub> power	1.0 w
13.	R <sub>x</sub> power	1.0 w
14.	DataSize	1000 Byte
15.	DataRate	5K bits/s

The existing system simulation parameter used to compare with the proposed system that is used during all conducted simulation experiments are presented in Table 4.2.

#### 4.2: Existing system Simulation Parameters

Serial No.	Parameter Name	Parameter Value
1.	Area of flat grid	250m*250m
2.	No. of sensor nodes	19
3.	No. of mobile nodes	1
4.	No. of base station	1
5.	MAC Layer Protocol	MAC/802.15.4
6.	Simulation time	100 s
7.	Antenna type	<i>OmniAntenna</i>
8.	Radio model	<i>TowRayGround</i>
9.	Transmission range	30m
10.	Routing protocol	DSR
11.	energy model	100 Joules
12.	T <sub>x</sub> power	1.0 w
13.	R <sub>x</sub> power	1.0 w
14.	DataSize	1000 Byte
15.	DataRate	5K bits/s

### 4.3 The Performance Evaluation of Proposed Method

In this section, we compare our proposed system i.e. Optimizing Indoor Tracking system for Wireless Sensor Network using ZigBee with the existing system. Existing system has the drawback in localizing the network and locating the sensor nodes while they are moving. As literature survey suggested, sensor nodes in the ZigBee WSN has low range for transmitting packets and has low power capacity and they have to perform multiple tasks with such limited resources. So, we proposed this unique system to overcome the problems we find out during our research. Proposed system fetches the location of deployed nodes very accurately, compute the distance among them, checks the battery level of nodes and in the end make the

connection to transfer data. By computing the distance, a mobile node exactly knows their data will be sent successfully or lost trying.

To compare the existing work with proposed work, we are performing evaluation on the basis of throughput, delay, packet delivery ratio. We also check distance of every node after a given interval of time to let know the sensor nodes that they are still connected with other sensor nodes. This increases the throughput and reduces the packet loss which eventually enhances the proposed system. The residual energy of proposed system is also computed.

In our method, the sensor nodes are deployed randomly in 400x400 topography. The scenario is created by considering the indoor pathways available for movement. The different types of sensor nodes are Sensor Nodes (SN), Mobile Nodes (MN) and Base Station (BS) that spread across the network to check the data accuracy. Sensor nodes have the transmission range of 30 meter and to perform the transmission *onmiAntenna* is used. We use the standard *EnergyModel* with initial energy 100 joules. Sensor nodes consume energy only when they are sending, receiving or tracking the other sensor nodes. Otherwise, they are in sleep mode.

The Ad-hoc On-demand Distance Vector (AODV) routing protocol is best suitable for proposed system. This will provide the flexibility to the proposed algorithm to compute the distance between nodes when it was demanded, this will reduce the unnecessary throwing off the data packets to check the position and availability of node. This basic application of AODV is on-demand computation of distance between source node i.e. sender node and destination node i.e. receiver node, another application of AODV is, it helps to maintains the routing table for each node but this will create the overhead for nodes and this will also consume more energy to maintain it after every call. To overcome this, we use the distance table computed by system.

The below Figure 4.2, shows the difference between sensor node, mobile node and sink node by analyzing the different colours for different type of nodes and also labels can show the exact picture of topology. The whole nodes deployment is done under 400x400 topography; so that ZigBee wireless sensor network can be depicted that requires a small area and less number of nodes.

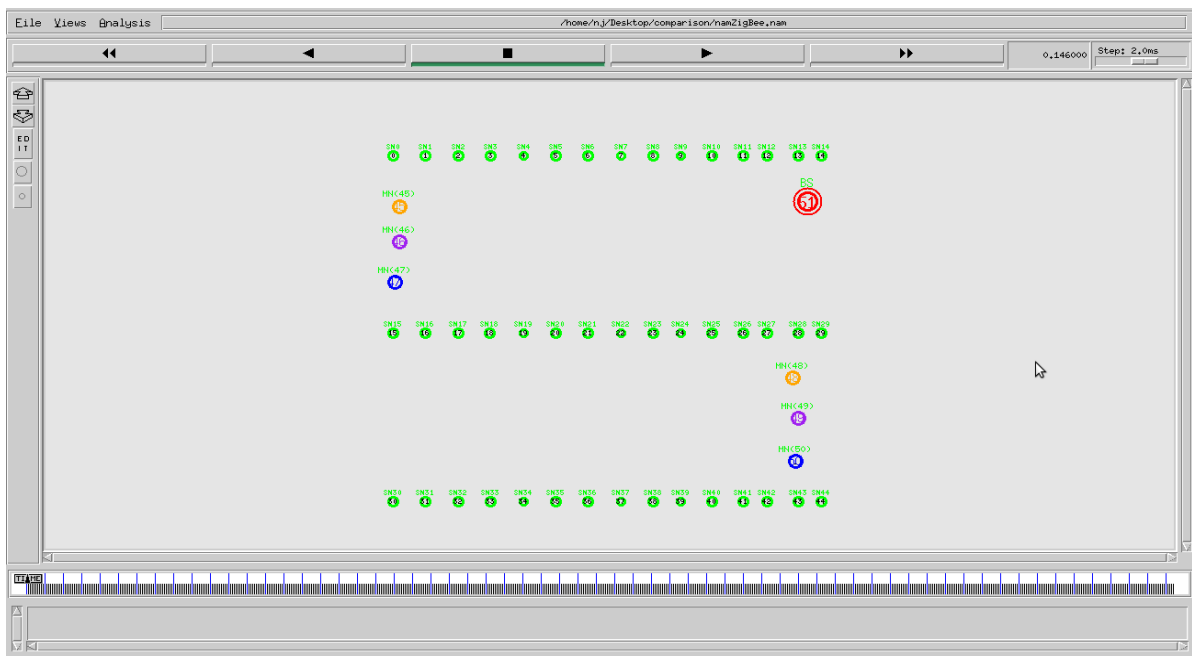

**Figure 4.2: Sensor nodes, Mobile Nodes and Sink Node.**

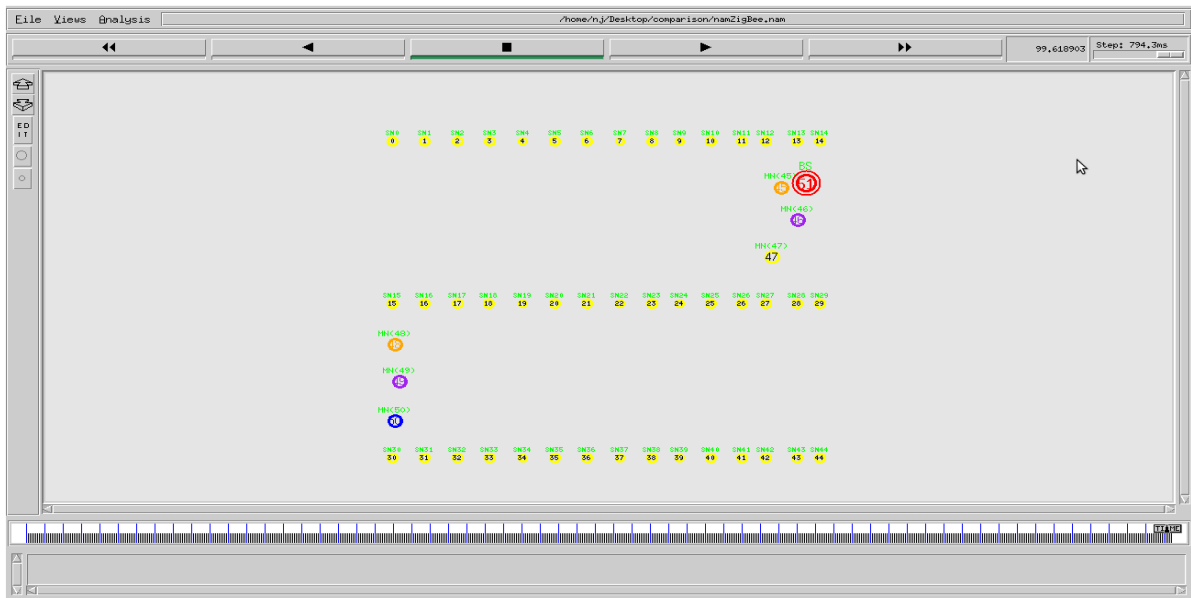

**Figure 4.3: Energy level of sensor nodes.**

Figure 4.3 shows the energy level of different nodes at the end of simulation. The energy level of all the sensor nodes goes down after performing multiple tasks like sensing, maintain table, communicating with each other and eventually sending the data packets to sink node. Mobile nodes also moved from their source to the destination, some are towards sink node and some are away from it. This could be done to experimentally, as it is unpredictable to guess the direction of mobility in case of mobility.

For connectivity of sensor nodes and mobile nodes, RSSI localization technique is used and for energy level, standard energy model is used. The computed distance using RSSI is used for locating the node and further communication.

## 4.4 Evaluation Metric

The performance metrics are used to evaluate the performance of our algorithms and for comparison issues. The important performance metrics are evaluated in the following:



- 1. Tracking Error:** accuracy of finding the location it is measured by taking the averaged Euclidean distances between the real coordinates and estimated coordinates. It presents the uncertainty of having the correct target's location.
- 2. End-to-End Delay:** This is the average time consumed by every node to deliver packets from source node to the destination node. For computing end to end delay, all the parameters are included which are queuing delay (Every router has its own queuing delay) at each node, transmission delay, processing delay, and propagation delay.
- 3. Throughput:** Throughput is the rate at which something can be processed. Throughput or Network throughput is the ratio of total amount of data reaches the receiver from the sender to the time it takes for the receiver to receive the last packet. It is represented in bytes per second or packets per seconds.
- 4. Packet Delivery Ratio:** Packet delivery ratio is calculated by dividing the number of packets received by the destination through the number of packets generated or sent from the source. It describes the loss rate. The Performance is better when packet delivery ratio is high.
- 5. Energy:** the very basic feature of a sensor node is its energy level, and while we are taking ZigBee WSN, this becomes more important to save. A node can consume energy with 4 types i.e. transmission power, receiving power, idle power, and sleep power. The initial energy of nodes are same but not for sink node. Comparatively, sink nodes have higher energy level than others.

## 4.5 Result Analysis

### 4.5.1 Comparison of Tracking Error of Existing and proposed System

In the simulation experiments are performed to show tracking error. Figure 4.4 exhibit the accuracy of our proposed method under different sensor density over different time. The result very low tracking error and this lets the localization process be accurate. The recent error of each round is used to make the methods balance between error and energy in order to prevent the tracking error from increasing. Approximately, the tracking error in all is the same there is no improved in error but we did our best to prevent it from increasing. The average tracking error increases by time due to the reduction in the number of sensor node as some of them dead nodes due to power loss.

As we can see from the experimental results in Figure 4.4 when a mobile node approaches any reference node, our method can accurately determine the position with error distance less than 1 meter that is the improvement of 8% in tracking error. At the same time, the method is accurate enough when the mobile node is moving closer to the fixed sensor.

Furthermore, the average tracking error calculated quite stable in Figure 4.4.

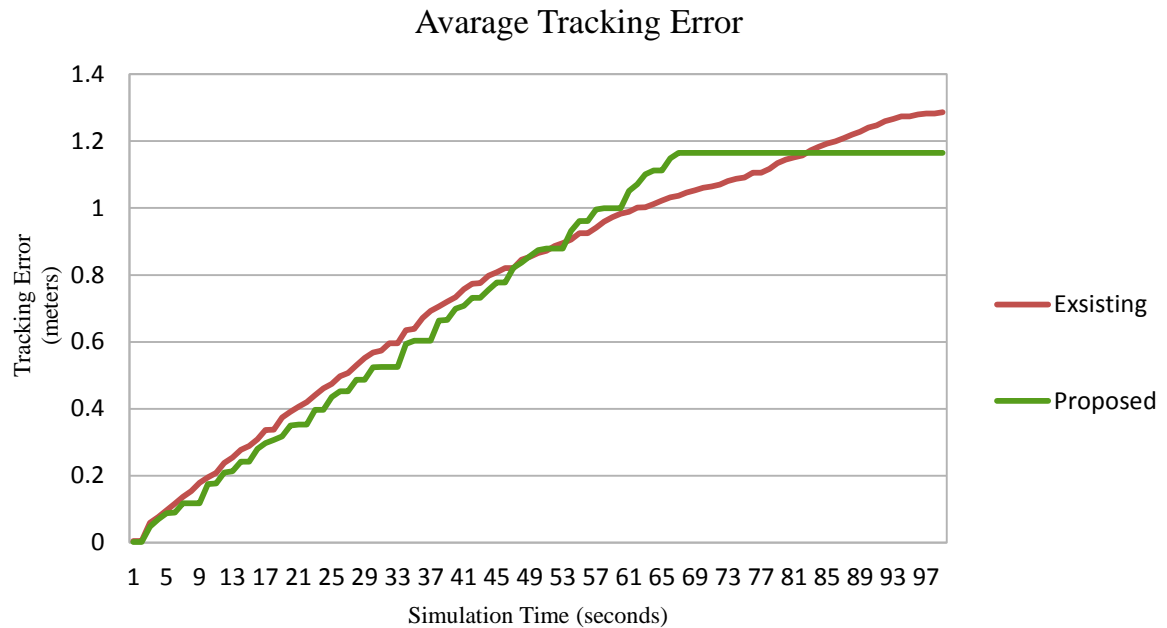

**Figure 4.4: Tracking Error of existing and proposed system**

## 4.5.2 Comparison of Throughput of Existing and proposed System

Number of bytes processed during a specified time and usually measured in Kbps, Mbps, and Gbps. The throughput has been obtained from the simulation in order to evaluate the performance of the proposed model. The throughput is calculated at an interval of every 1 second.

The proposed system has the average throughput of 91095 and existing system with 63020 approximately. That is the improvement of 45% in delivering the packets successfully to destination. The below graph shows the same. The Figure 4.5 represents the comparison between existing model and proposed model of network throughput. The x-axis represents the simulation time in seconds and y-axis represents the network throughput in packets for both systems. This shows that as the time passes proposed model increases its throughput as

compared to the existing model.

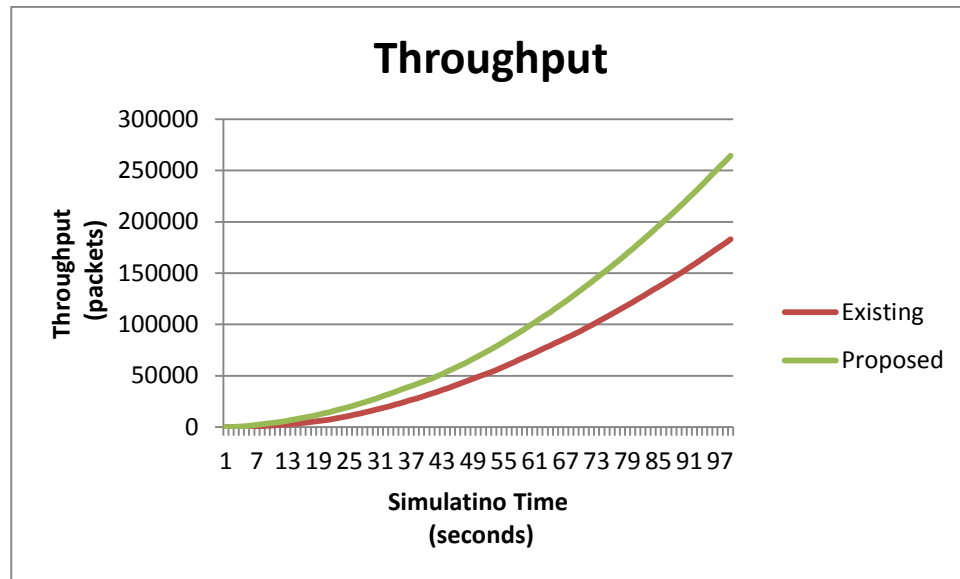

Figure 4.5: Throughput of existing and proposed system.

### 4.5.3 Comparison of Delay of Existing and proposed System

The sensor nodes need to check the nodes availability in their own transmission range at every 0.5 seconds. To get the location of mobile nodes and sensor nodes increases the overall burden of network. To perform this, average time consumed by a packet, after including delay caused by discovery of route and delay in queue to arrive at the base station. Data aggregation also increases and packet in queue also increases the delay. But these all are managed after the algorithm applied on the network. The peak of delay is recorded nodes starts getting coordinates of other nodes and they have to communicate with other nodes too.

When the nodes transmit the data in the uniform formation by knowing the exact location of other nodes location, it reduces the delay time of tracking every time and the probability

of losing data packets can be reduced. Such heavier volumes in result increases the transmission delay from the given WSN scenario. The can improve the proposed model effectively.

The data collected after executing the proposed algorithm shows that the delay is very low as compared to the existing model. This also increases the accuracy and effectiveness of the network. This will send the critical data more rapidly than other algorithms.

The Figure 4.6 represents the comparison between existing model and proposed model of network delay. The x-axis represents the simulation time in seconds and y-axis represents the network delay in packets for both systems. This shows that the delay packets are reduced by the proposed model and controlled after a sudden hike into it. The delay can be caused by multiple factors like sending sensing signals to gather information about neighbors, storing them into a nodes table, parsing the node's table to get the nearest node to transfer bytes of data and also to check if that particular node is awake and has the appropriate level of energy to transmit the required set of bytes. Proposed system shows that it improved and better than existing.

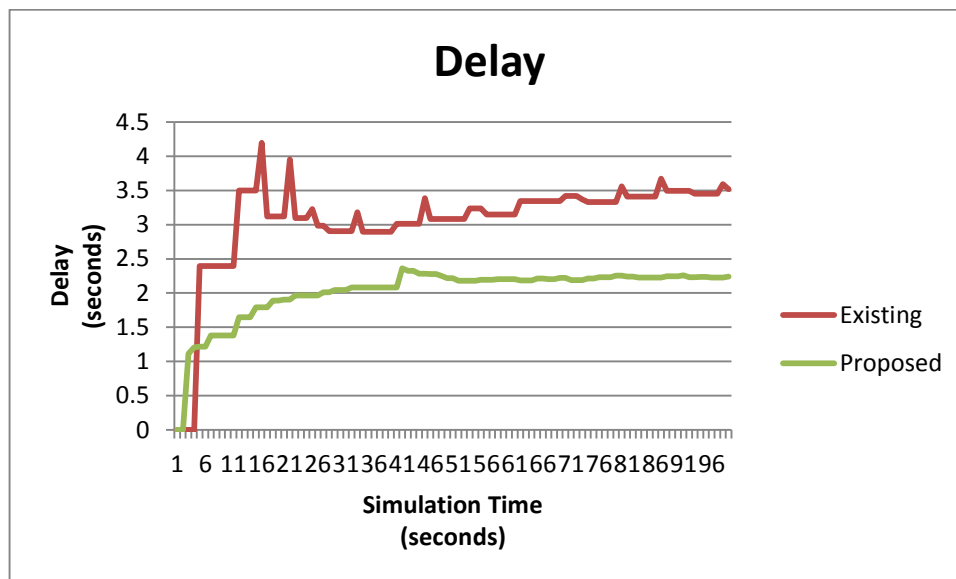

**Figure 4.6: Delay of existing and proposed system**

This indicates that the number of mobile elements is not only depended on the path constraint, there are also other factors such as the shortcoming of the communication ranges between two neighbour mobile elements

#### 4.5.4 Comparison of Packet Delivery Ratio of Existing and Proposed

##### Method

The packet delivery ratio is the ratio of packets successfully received to the total sent. Throughput is the rate at which information is sent through the network. If a network becomes congested and there is good discipline, packets may queue up at the source and never enter the network. Those packets will not contribute to throughput, but because they are never sent, won't affect the PDR at all. The danger is having a traffic management that strives to keep the PDR high by limiting traffic so much that throughput suffers. From a user's standpoint, throughput is the important thing. However, from a network design standpoint, PDR is important to identify issues that might lead to poor throughput.

It is the ratio the number of delivered data packet to the destination which includes the data packets sent to check the position and energy level at every 0.5 seconds. This illustrates the level of delivered data to the destination. It is calculated by subtracting lost packets from total number of packets and divided by the number of packets transmitted.

Packet delivery ratio graph depicts the line chart of delivering data at a particular interval of time. As the simulation runs for 100 seconds and at every 0.5 seconds algorithm updates the neighbouring table. Only transmitted data packets are stored in file by excluding the sensing data packets to maintain the neighbors table, frame bits send to check the energy level etc. To show the effect of this value on the number of mobile elements, it is observed that for a large network area, the number of mobile elements is considerably higher than that for small network area. Moreover, the number of mobile elements remains constant when the path constraint is greater than a specific value.

The Figure 4.7 represents the comparison between existing model and proposed model of packet delivery ratio. The x-axis represents the simulation time in seconds and y-axis represents the packet delivery ratio in packets for both systems.

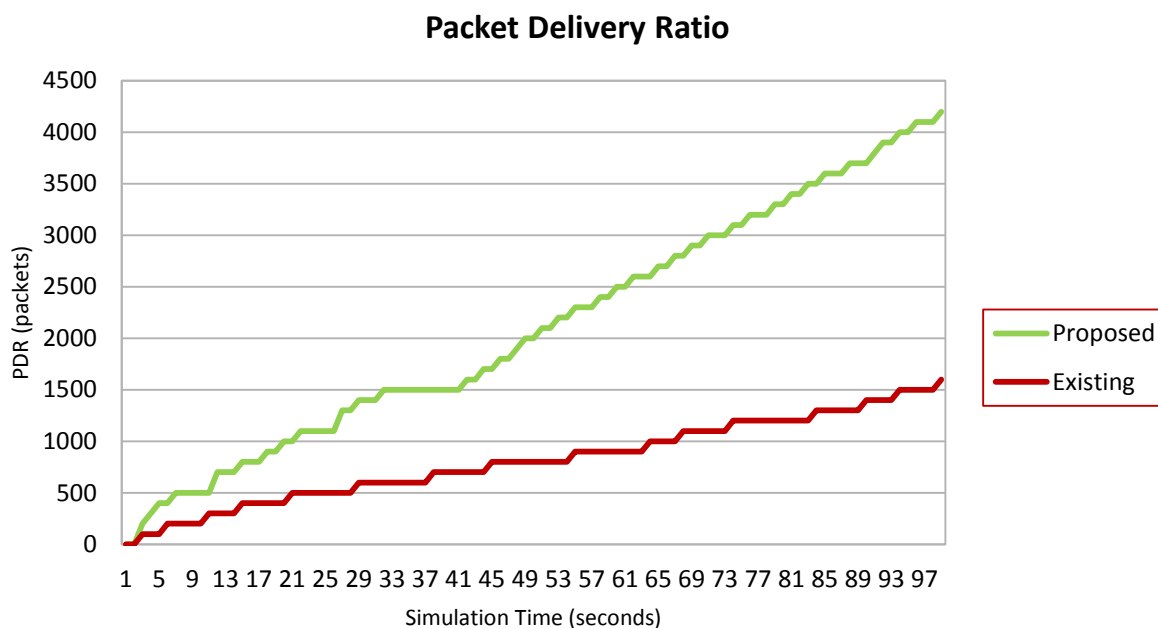

**Figure 4.7: Packet Delivery Ratio of existing and proposed system**

#### 4.5.5 Comparison of Residual Energy of Existing and Proposed System

The initial energy of sink node is 100 joules but as the simulation goes on this will continuously decreasing due the packet receiving, sending the coordinates to sensor nodes at every 0.5 seconds. As it has higher energy than others so this node will survive till end.

We computed the residual energy an every 0.5 and algorithm shows that proposed system can lasts for approximately another 100 seconds. The energy can be saved after preventing the sensor nodes to throw signals to sense the neighbour nodes. Residual energy is the remaining energy of sink node that shows the survival of network and data collection procedure.

Residual energy of any node shows the remaining battery power to survive the physical condition. As sensor nodes deployed in ZigBee wireless sensor networks has very limited energy of itself, proposed system maintains their survival throughout the simulation.



The figure 4.8 represents the comparison between existing model and proposed model of residual energy. The x-axis represents the simulation time in seconds and y-axis represents the residual energy of sink nodes respectively. The graph shows that the residual energy of proposed energy is higher than existing system. This means that the life of indoor wireless systems are increasingly using ZigBee Wireless Sensor Networks.

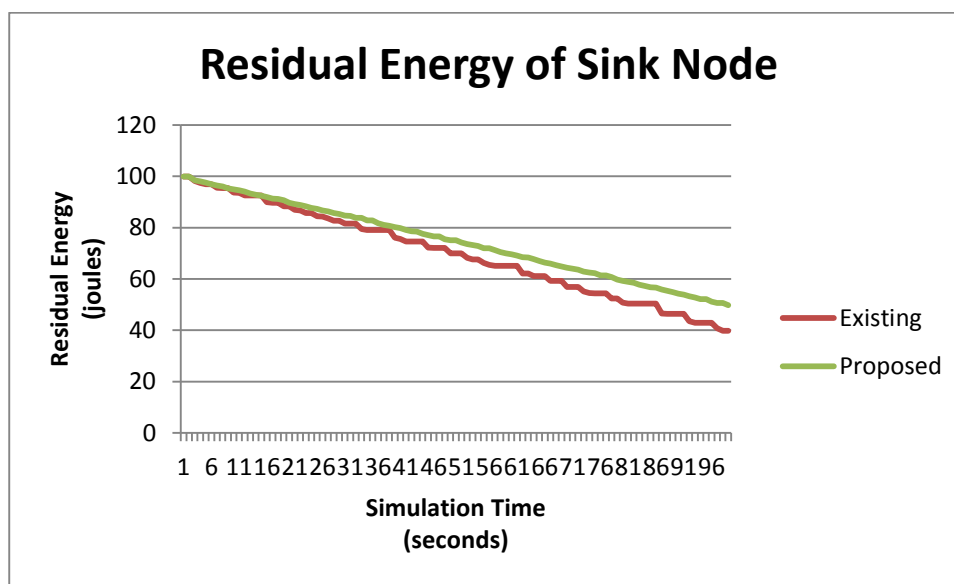

**Figure 4.8: Residual energy of existing and proposed system**

Initial energy of proposed model and existing model is same i.e. 100 joules. The topography pater of both system is different I nature and existing system used less number of sensor nodes and the deployment of nodes are also half the size of proposed system. Due to this topography and nodes deployment of both systems, we can deduce that proposed system can survive twice the existing system because proposed system handles the pressure twice the existing system.

## 4.6 Performance Evaluation

The performance evaluation is to compare with the existing model where localizing is not accurate as proposed system does. The average values of different parameter are listed below with the approximately expected improvement of the system.

Every system has a loophole to repair or drawback to overcome this could be done by measuring the results of existing system with the proposed system. Through the comparison of existing and proposed model, we can deduce that proposed model is better, efficient and effective than the others.

**Table 4.3: Parameter's average of proposed and existing system.**

Parameters	Proposed system (average)	Existing system (average)	Improvement %(approximately)
Tracking Error	0.73	0.79	8%
Throughput (bit/second (bps))	91095	63020	45%
Delay(millisecond(ms))	2	3.1	36%
PDR (bit/second (bps))	2107.1	1400	73%
Residual Energy (joules)	74.7	69.9	7%

As table 4.3 shows that, the proposed system is more efficient than the existing system in terms of throughput, delay and packet delivery ratio. So, this could be deduced that the overall performance of the proposed model is greater than the existing model.

## **Chapter Five**

# **Conclusion and Future Work**

Finally, this chapter summarizes the whole thesis, demonstrates how the stated aims and objectives have been achieved, and proposes some areas for further study in the future.

## 5.1 Conclusion

This thesis presents Indoor tracking using ZigBee Wireless Sensor Network. The proposed algorithm is designed after considering all the loopholes which may affect the environment. Heterogeneous sensor nodes are deployed in the ZigBee wireless sensor network to measure the effectiveness and efficiency of the proposed system. The proposed system can divide the implantation of algorithm into mainly three parts i.e. ensuring the availability of sensor nodes while connection and path formation by considering the residual energy of sensor node and store the energy into a trace file; fetching the locations of sensor nodes, mobile nodes and sink node using trilateration technique and store the location into a trace file and in the end, using Received Signal Strength Indicator (RSSI) technique determine the distance between each and every sensor node, mobile node and sink node and store the distance into a trace file. This process iterates itself after every 0.5 seconds. The trace tables of energy and distance are updated and provide the exact figures throughout the simulation. The proposed model is designed to eradicate the drawbacks of the existing system by merging the numerous algorithms together to develop a new and improved solution. The proposed model improved the indoor tracking systems lifetime using ZigBee wireless sensor network. This will also help to prolong the existence of network and work to sense and transmit data for a long time. The proposed model works on the principle of collecting information first rather than sending it. The calculation of numerous parameters like localization or distance

and building the centralized trace table for the sensor nodes to provide the identical information to each node helps the proposed system to prolong the lifetime of the sensor network and more importantly increases the accuracy of the system. To get the assurance of working efficiency, effectiveness and accuracy of the proposed model, it is examined for various parameters like throughput, delay, residual energy and accuracy. The combination of examined collected data, trilateration and RSSI for tracking the indoor scenarios makes it more adaptable and effective than others.

A performance result of this method has been measured and compared with the original RSSI method using NS-2 simulator. All the achieved simulation results have shown better performance for the proposed methods as compared to the original method. The Tracking Error improved by 8% and power consumption improved by 7%. Furthermore, the new network performance measurements have obtained a good value compared with the other measures in term of the network performance measurements such as packet delivery ratio (PDR), delay and throughput improved by 73%, 36% and 45%, respectively.

## **5.2 Future Work**

The future investigation could be done to extend the proposed power-efficient system to multiple target scenarios and increasing localization accuracy by focusing on other localization methods, in addition to implementing the proposed approach on real sensor nodes. The future work includes implementing and testing the efficiency of the proposed system in real sensor network application for tracking multiple mobile targets.

## References

Abusaimh, H., and Yang, S. H., (2009), Balancing the Power Consumption Speed in Flat and Hierarchical WSN. *International Journal of Automation and Computing*, 5(4), 366-375.

Abusaimh, H., and Yang, S. H. (2012). Energy-aware optimization of the number of clusters and cluster-heads in WSN. *In Innovations in Information Technology (IIT)*, 2012 International Conference on (pp. 178-183). IEEE.

Abusaimh, H., Shkoukani, M., and Alshrouf, F. (2014). Balancing the network clusters for the lifetime enhancement in dense wireless sensor networks. *Arabian Journal for Science and Engineering*.39,3771–3779

Akyildiz, I.F., Su, w., Shankar Subramaniam, y., and cayirci, E., (2002), Wireless sensor networks: a survey, *Journal of Computer Networks, Elsevier Science*, 38(4), 393-422.

Akyildiz, I.F., and Vuran, M.C., (2010), Wireless sensor networks, 1<sup>st</sup> ed, UK: *John Wiley & Sons*.

Alhmiedat, T., (2009), Tracking Mobile Targets Through Wireless Sensor Networks, (published doctoral dissertation), Loughborough University's Institutional Repository: UK.

Alhmiedat, T., Samara, Gh. and Abu Salem, A., (2013), An indoor fingerprinting localization approach for ZigBee wireless sensor networks. *European Journal of Scientific Research*, 105 (2), 190-202.

Aliance, Z., (2008), ZigBee Specifications, ZigBee Standard Organisation: San Ramon, CA, USA.

Chandane, M. M., (2012), *Performance Analysis of IEEE 802 . 15 . 4*, *Int. J. Comput. Appl.*, 40(5), 23– 29.

Chandra-Sekaran, A., Nwokafor, A., Shammash, L., and Kunze, Ch. ,(2009), A Disaster Aid Sensor Network using ZigBee for Patient Localization and Air Temperature Monitoring, *International Journal on Advances in Internet Technology*, 2 (1), 68-80.

Chen, W.P, Hou, J.C., and Sha, L. (2004), Dynamic clustering for acoustic target tracking in wireless sensor networks, *Journal of Mobile Computing, IEEE Transactions*, volume 3, issue 3, page 258-271.

chen, y., yang, c., chang, y., and chu,c.(2006), A RSSI-Based Algorithm for Indoor Localization Using ZigBee in Wireless Sensor Network, *Int. J. Digit. Content Technol. it's Appl. Digit. Content Technol. its Appl.*, 5(7), 407–416.

Chu, C. H., Wang, Liang, C. H. C. K. W., Ouyang, J. H., Cai, and Chen, Y. H., (2011), High-accuracy indoor personnel tracking system with a ZigBee wireless sensor network, *7th Int. Conf. Mob. Ad-hoc Sens. Networks, MSN 2011*.

Cook, B., Buckberry, G., Scowcroft, I., Mitchell, J., and Allen, T., (2005), Indoor Location Using Trilateration Characteristics, *London Communications Symposium*.

deva Gifty, J. J. and Sumathi, K., (2016), ZigBee Wireless Sensor Network Simulation with Various Topologies, *Int. Conf. Green Eng. Technol.*

Ferrari, G., Medagliani, P., Di Piazza, S. and Martal`o, M., (2007), Wireless sensor networks: performance analysis in indoor scenarios, *EURASIP Journal on Wireless Communications and Networking*, Article ID 81864, 14 pages doi:10.1155/2007/81864.

Ghumare, S., Labade, R., and Gagare, S., (2015), Importance of Localization for Tracking

Mobile Target in Wireless Sensor Network, Information Processing (ICIP), 2015 *International Conference, IEEE*.

HakanKoyuncu, Shuang Hua Yang, (2010), A survey of indoor positioning and object locating systems, *International Journal of Computer Science and Network Security(IJCSNS)*, 10(5), 121-128.

Jia, Z., Wu, C., Li, Z., Zhang, Y., and Guan, B., (2015), The indoor localization and tracking estimation method of mobile targets in three-dimensional wireless sensor networks, 15, 29661–29684.

Larranaga, JMugira, L., jyyh Lopez-Garde, J. M.,and Vazquez, J. I. ,(2010), An Environment Adaptive ZigBee-Based Indoor Positioning Algorithm, 2010 *Int. Conf. Indoor Position, Indoor Navi*.

Lu., z., and Yang., h., (2012), Unlocking the power of OPNET moncity press, United States of America: Cambridge University Press, New York.

Obaid, T., Abou-Elnour, A., Rehan, M., Muhammad Saleh, M., and Tarique, M., (2014), ZigBee Technology and Its Application in Wireless Home Automation Systems: a Survey, *Int. J. Comput. Networks Commun*, 6(4), 115–131.

Oracevic, A., and Ozdemir, S., (2014), A survey of secure target tracking algorithms for wireless sensor networks, 2014. *World Congr. Comput. Appl. Inf. Syst. WCCAIS 2014*.

Pino-Povedano, S., Arroyo-Valles, R., and Cid-Sueiro, J,(2014), Selective forwarding for energy-efficient target tracking in sensor networks, *Journal of SignalProcessing, Elsevier Science*, volume 94, pages:557-569.

Pu, C.-C., (2009), Development of a new collaborative ranging algorithm for RSSI indoor location tracking in WSN, (published doctoral dissertation), Dongseo University, South



Korea.

Shinde, V., Panchal, R. and Panchal, J., (2016), ZigBee based indoor location tracking system. International Journal of Advanced Research in Electrical, Electronics and Instrumentation Engineering. 5(4).

Sohraby, Kazem, Daniel, Minoli, and Taieb and Znati. (2007). Wireless sensor networks: technology, protocols, and application, John Wiley&Sons.

Stüber, G.L, and Caffrey. J, (1999), the mobile communications handbook, (2<sup>nd</sup> ed,) CRC Press, (J D Gibson editor) Radiolocation Techniques

Tadakamadla, S., ( 2006), Indoor local positioning system for ZigBee, based on RSSI, *Mid Sweden Univ.*

Xiong , Z., Song, .Z., Scalera, A., Ferrera, E., Sottile, F., Brizzi, P., Tomasi, R., and Spirito, M.A. , (2013) ,Hybrid WSN and RFID indoor positioning and tracking system, EURASIP Journal on Embedded Systems 2013, 2013(6), (online):

<http://jes.eurasipjournals.com/content/2018/1/6>.

Yang.,s.,h., (2014), Wireless sensor networks principles, design and applications, Springer London Heidelberg New York Dordrecht.

Yick, J., Mukherjee, B., and Ghosal, D., (2008), Wireless sensor network survey, Journal of computer networks, Elsevier Science, 52(12), 2292-2330.